



LIGHTCOMMANDER II 24/6

LIGHTCOMMANDER II 48/6

User's Manual

Version 2.59

August 2007

Table of Contents

0. Introduction	4
0.1 How to use your Operator's Manual	4
0.2 Specifications and Installation	5
0.3 Display and Top Menu	5
1. Single Channels	8
1.1 Presets and Masters	8
1.2 Add - Swop Buttons	8
1.3 Extra Channels (AUX 1-6)	9
2. Preprogrammed Pictures (Memories)	10
2.1 Memory Pages	10
2.2 Programming Memories	11
2.3 Switch Memories	12
3. Chaser Programs	13
3.1 Programming ON-OFF Chases	14
3.2 Programming Real-Level Chases	15
3.3 Programming Memory Chases	15
3.4 Recalling a Chase	16
3.5 Controlling the Speed of a Running Chase	16
3.6 Controlling the Fade between Chase Steps	17
3.7 Chases on Memory Faders	18
4. Dipless Crossfade (X-Fade)	19
4.1 Automatic Crossfade between Memories	20
4.2 Manual Crossfades between Memories	21
4.3 X-Fading a Chaser Program	22
5. Preprogrammed Lighting Shows (Sequences)	23
5.1 Programming Sequences	23
5.2 Recalling Sequences	24

6. Preview and Modifying	25
6.1 BLIND Function	25
6.2 PREVIEW - Output Listing	25
6.3 Output Limit	26
6.4 Previewing and Modification of Memories	27
6.5 Modifying Chase or Sequence Steps	28
6.6 Previewing a Chase	29
6.6.1 Preview at the Chaser Section	29
6.6.2 Preview a Chase on Memory	29
6.6.3 Previewing a Chase linked to a Sequence Step	29
6.7 Preview and Modifying a running X-Fade	30
6.7.1 Preview on the following X-fade Steps	30
6.7.2 Modifying X-Fade Steps	31
6.7.3 Changing X-Fade Scene Order	32
7. Special Functions	33
7.1 Single Channel Setups	33
7.1.1 Doubling the Channel Number (WIDE Function)	33
7.1.2 Connection Desk Channel to Dimmer Channel (Softpatch)	34
7.1.3 Dimmer Curve	35
7.1.4 Swop Disable	35
7.2 Changing Board Operation Mode	36
7.2.1 Switch Memories	36
7.2.2 Keyswitch	36
7.2.3 Theatre Sequence	37
7.3 Backup on Cue Cards	38
7.4 CLEAR ALL Programs on the Desk	38
7.5 Automatic Test Routines	38
7.6 Adjusting Date And Time	38
7.7 HOLD Function	39
8. Remote Control and Linking	39
8.1 Master-Slave Operation	39
8.2 MIDI Functions	40
9. Input and Output	42
Index	43
Safety instructions	46
Declaration of conformity	47

0. Introduction

The MA Lightcommander II has been recognized for years as one of the best and most reliable boards for medium size show and high quality productions. With our new software 2.X, which is available since January 1994 and can also be installed in all older boards, we enable the Lightcommander II to perform numerous new functions. One of them, the Wide-Mode, doubles the number of usable channels, other functions will make the board even more user friendly.

0.1 How to use your Operator's Manual

The first chapters of this manual will introduce you to the basic functions of the Lightcommander II. The bottom line always indicates special functions on that subject. The graphic shows the described part of the board, or the contents of the display.

Chapters 6 to 8 describes the numerous special functions, the different display menus as well as the possibility of synchronizing the MA Lightcommander II via MIDI or couple two boards in master-slave mode.

Chapter 9 deals with the inputs and outputs on the backpanel of the MA Lightcommander.

The index in chapter 10 allows you to locate special subjects.

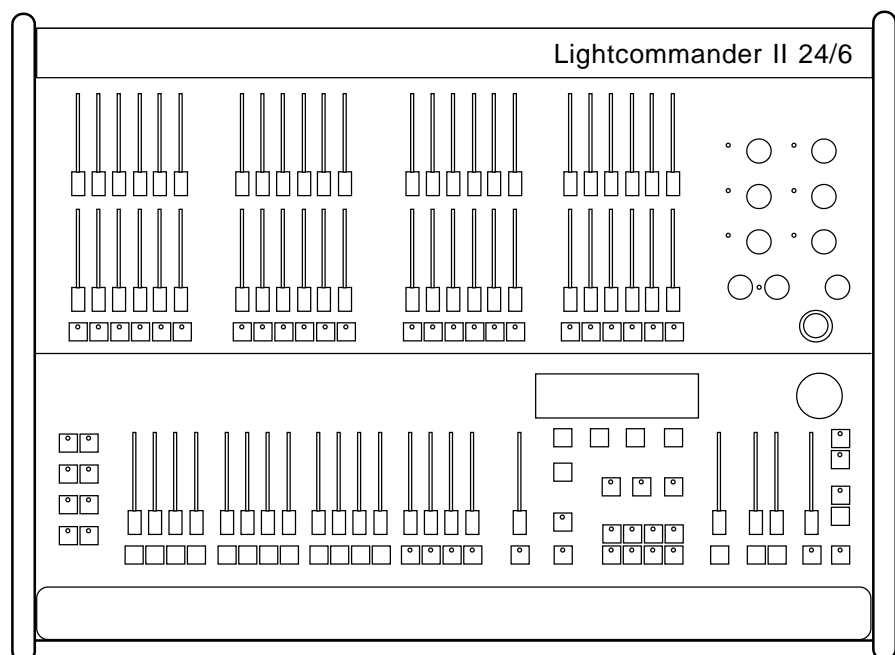

0.2 Specifications and Installation

The MA Lightcommander II is available in two versions: 24/6 and 48/6. Both versions have a 100 - 240 Volt AC input on the back panel. The signal outputs to your dimmers are: DMX 512 (1990) and 30 / 54 channel analog via Socapex EF337. Apart from the different numbers of channels, the two boards perform the same functions.

0.3 Display and Top Menu

The build-in LCD display informs you on the present program and in conjunction with the 4 buttons located directly below the display you have access to numerous special functions. The QUIT button always brings the board back to the Top Menu (shown below).

The specific functions of the 4 buttons are always described in the boxes of the display directly above them.

The Encoder wheel on the right of the display is used for data-input in conjunction with special functions shown in the display. All values and data that can be altered or changed by the Encoder wheel are always displayed in front of a dark background.

The following page lists all displays of the Lightcommander II. The page where to find the exact descriptions of the specific display and its functions is shown above the graphic.

TOP MENU - accessible via QUIT button

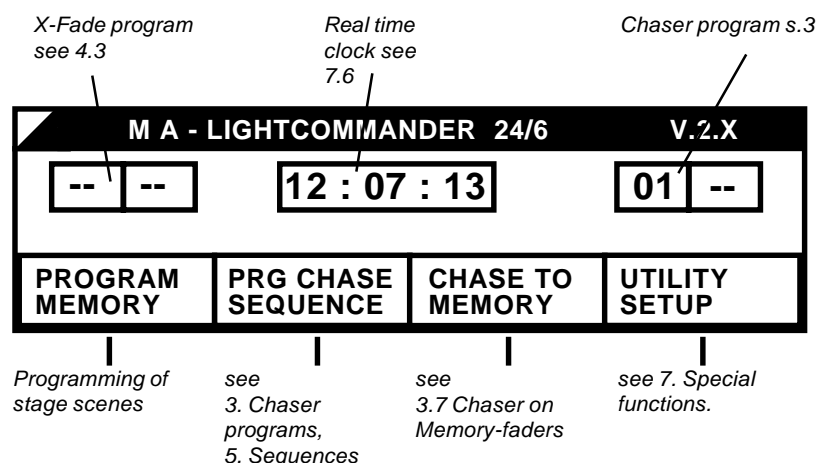

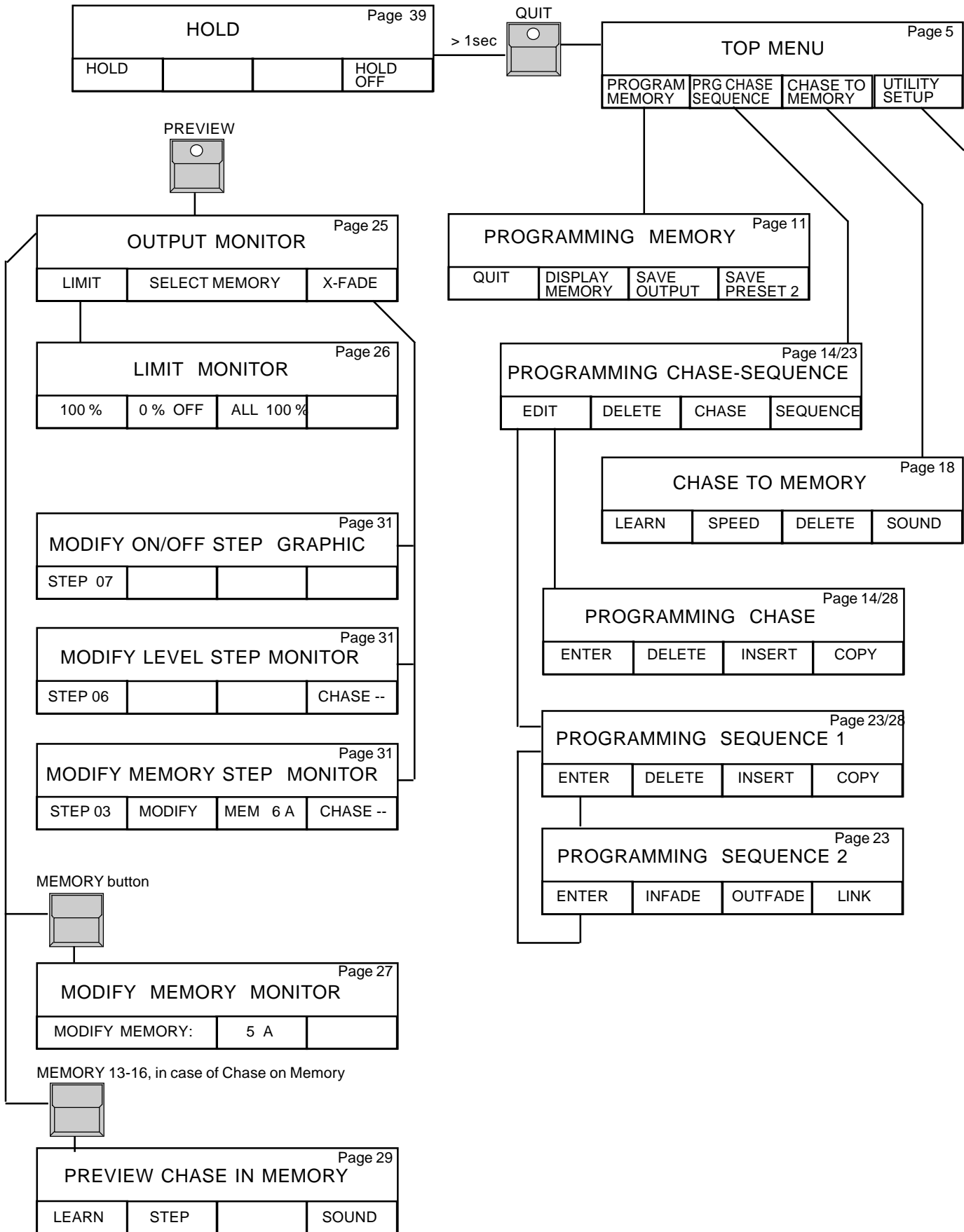

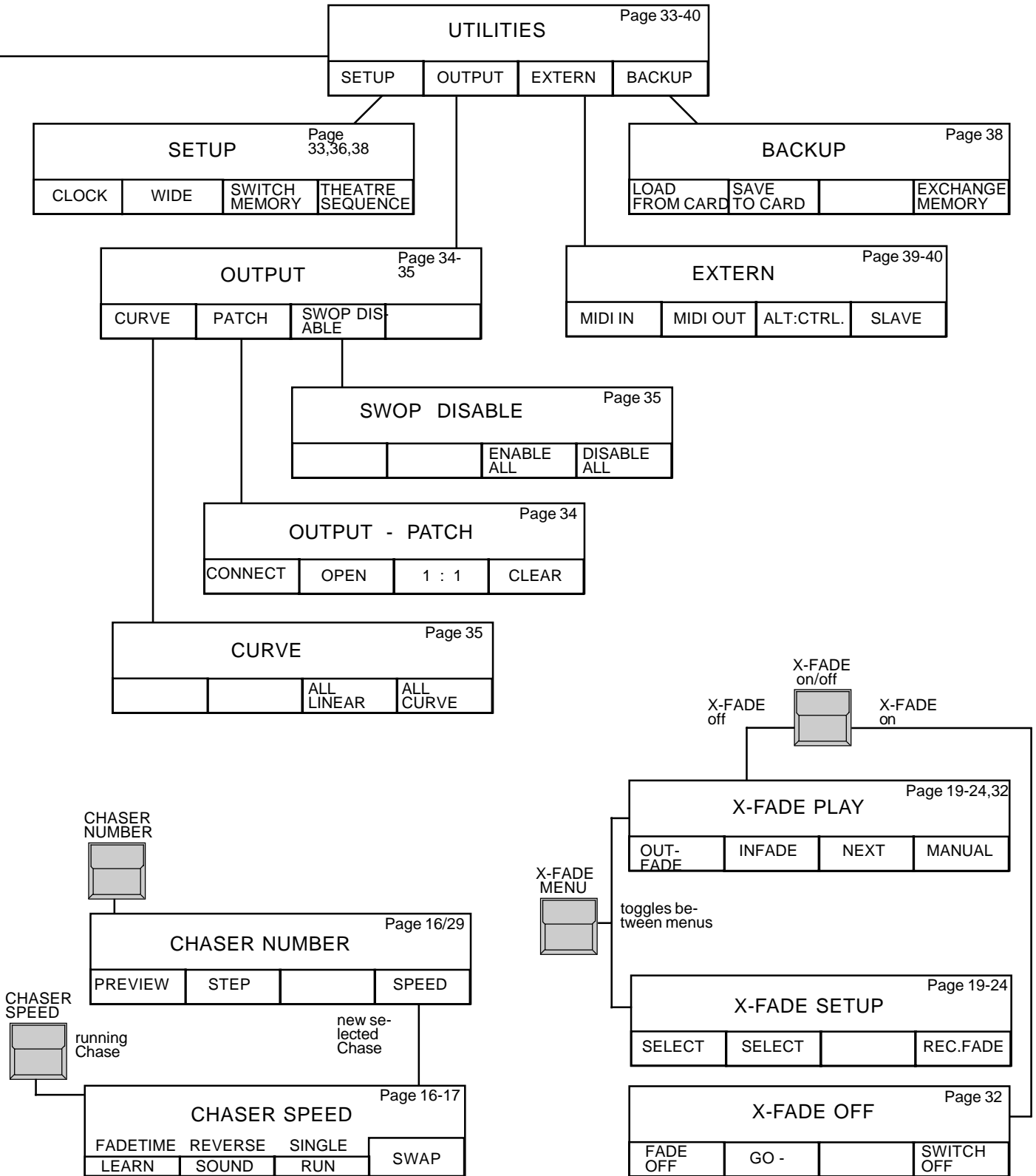

1. Single Channels

1.1 Presets and Masters

There are two sets of faders (Preset 1 and 2) and one set of flash buttons to control the single channels.

The Main Master controls the output and should be at 100% during standard operations.

Adjustments on the Presets can be faded in and out independently using the two Preset Master faders.

The LED at the single channel buttons show the actual intensity of the channel, but will change during Preview, Programming and Blackout operations.

The Blackout button (DBO) underneath the Main Master fader will clear the complete output, while the LED's will still inform about the intensity which comes up as soon as the button is released (exceptions: see 1.3 AUX Channels and 7.2.1 Switch Memories)

1.2 Add - Swop Buttons

The buttons will switch on the channel. The brightness of this effect can only be reduced by the Main Master.

If the SWOP function is switched on (LED in the SWOP button lits up), each press of a button will erase all other channels but the selected one (Solo effect).

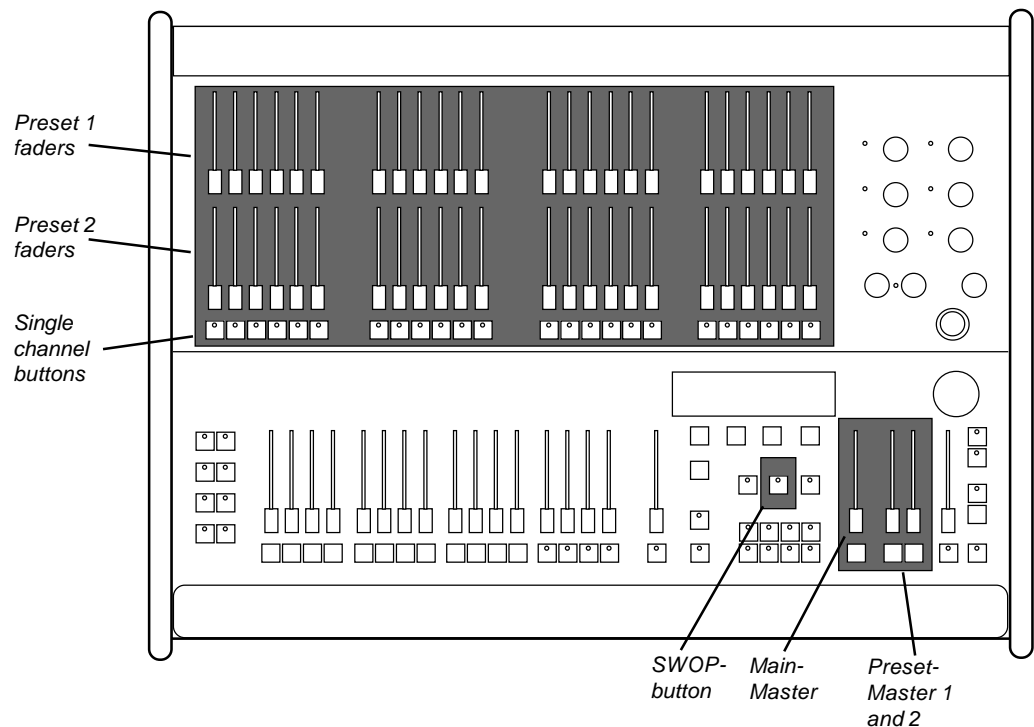

For further informations see:

Doubling the number of channels
Changing the channel order
Locking single channels against SWOP effect

- 7.1.1 WIDE Function
 - 7.1.2 Softpatch
 - 7.1.4 Swop Disable

1.3 Extra Channels (AUX 1-6)

Beside the 24 resp. 48 channels of the presets the Lightcommander II offers six additional channels via the potentiometers AUX 1 to AUX 6. Adjustments on this pots are independent from the Main Master, Blackout button or Preset Masters and are specially designed for the control of colour changers or other stage effects.

(As a part of preprogrammed stage scenes like memories or chases this AUX channels can also be mastered with the according fader)

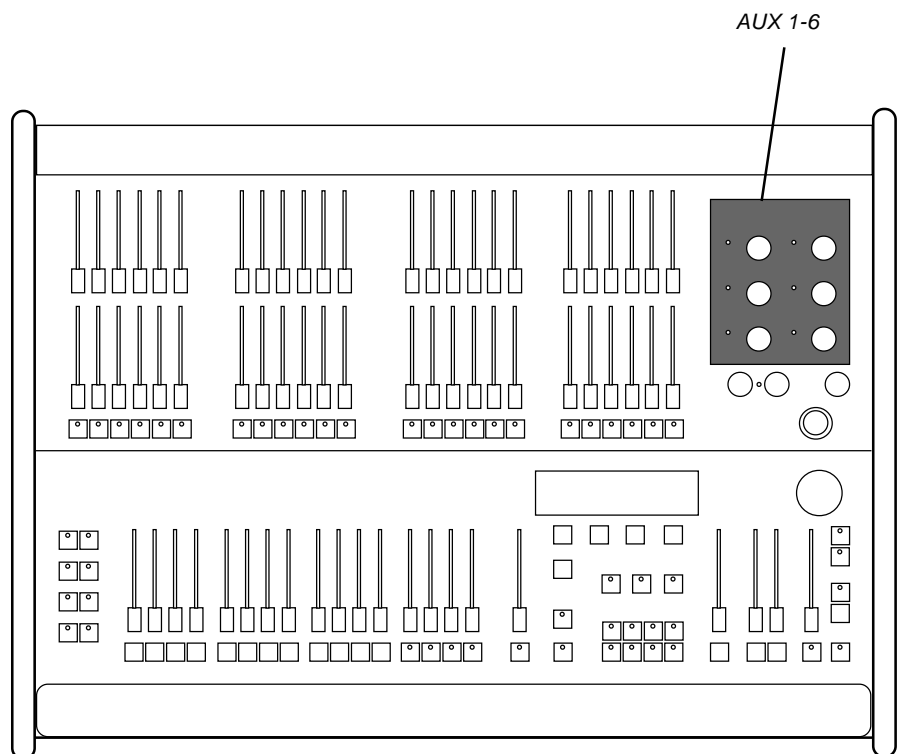

*For further informations see:
Colour changers in memories*

- 2.3 and 7.2.1 Switch Memories

2. Preprogrammed Pictures (Memories)

Adjusted stage scenes can be stored as Memories. Sixteen Memory Master faders with flash buttons offer control of this pictures. If the SWOP function is switched on, pressing a memory button will recall this picture and erase all other channels or memories on stage.

2.1 Memory Pages

Each of the 16 Memory faders can carry up to eight different pictures. The page buttons A to H preselect, which of this eight pictures is actually programmed or recalled.

As long as a Memory fader is pulled up, it will not be affected by changing the page selection. It will stay with its picture until it is returned to zero. Coming up again it recalls the picture on the newly selected page.

As long as one or more Memory faders are still working with an old page selection, the LED in the new page will flash.

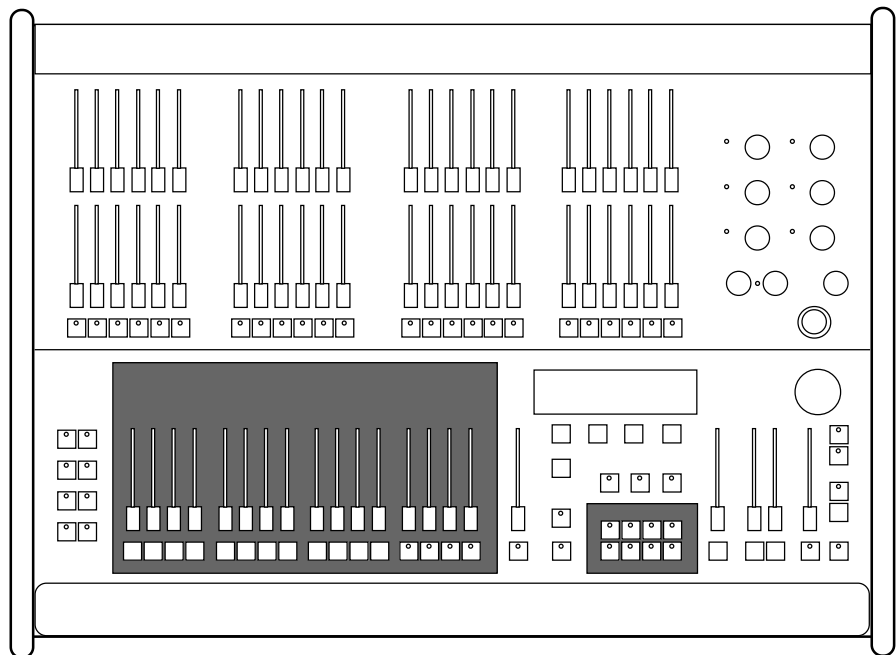

For further informations see:





*Chase effects on Memory faders
Dipless crossfade between Memories*

*- 3.7 Chase on Memory
- 4. X-Fade*

2.2 Programming Memories

Programming Memories is guided by menus of the build-in LCD display.

Operation mode:

1. Adjust stage scene via Preset faders or by recalling preprogrammed memories.
2.  **PROGRAM MEMORY** The first red button underneath the display switches the menu to "PROGRAMMING - MEMORY".
3.  Selection of one of the Memory buttons.
4.  **SAVE OUTPUT** The 3. display button of the menu "PROGRAMMING MEMORY" saves the actual stage scene under the pre-selected Memory number.
5.  The QUIT button switches back to the TOP MENU.

- 1-5** Quick programming mode:
 Keeping "PROGRAM MEMORY" button pressed and selecting a Memory Flash button stores the actual output as Memory.

MENU "PROGRAMMING - MEMORY" - accessible via the TOP MENU

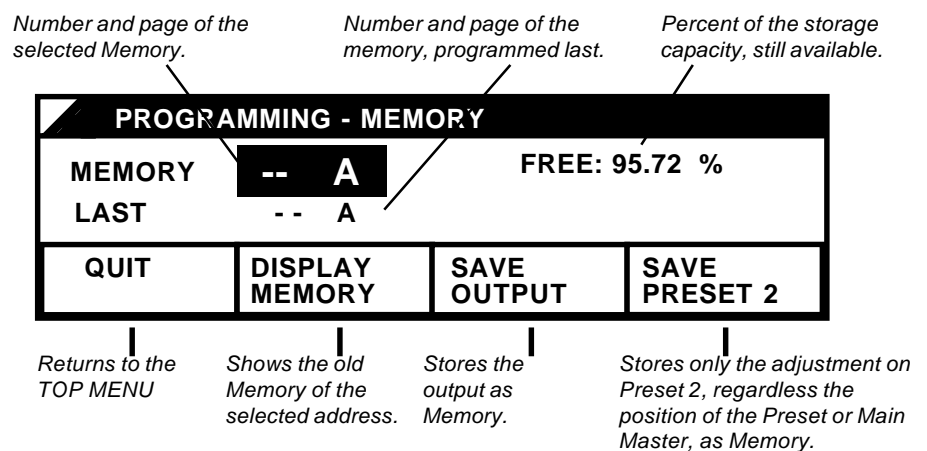

For further informations see:
 Preview and modify memories
 Blind Programming

- 6.4 PREVIEW
 - 6.1 BLIND function

2.3 Switch Memories

Additional 64 pictures can be stored onto the 8 Switch Memory buttons. Via the page selection it is possible to store and recall 8 pictures per button. Programming switch Memories works the same way as programming standard memories.

FLASH Mode: Like the Flash buttons of the 16 standard memories, the Switch Memory buttons will recall the memory as long as the button is held down.

It is optionally possible to change the Flash mode to a Toggle or Kill mode between on and off (particularly useful when controlling colour changers or effects, see 7.2.1).

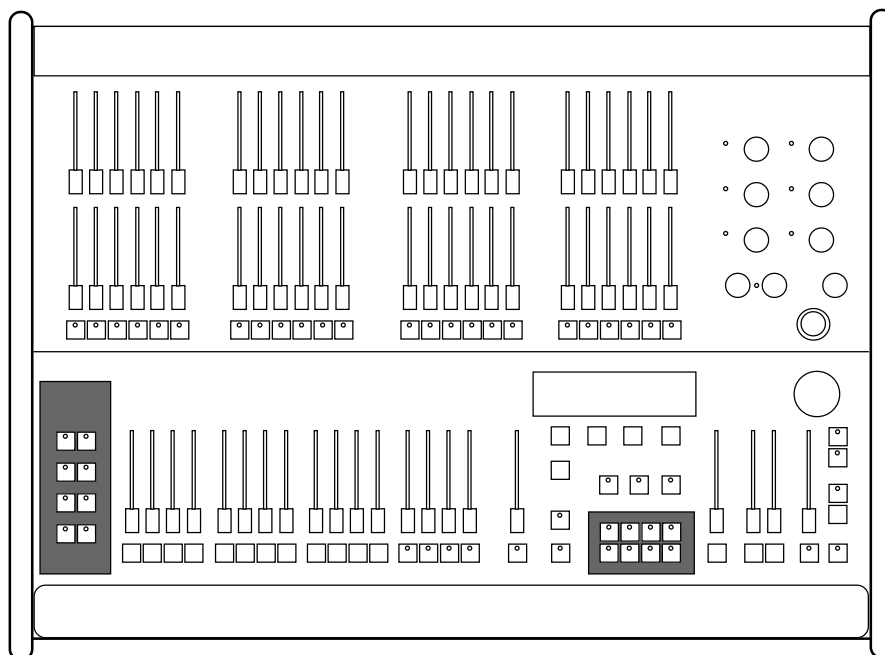

For further informations see:
Changing the Flash mode to Toggle or Kill mode - 7.2.1 Special Memories

3. Chaser Programs

Beside the static memories it is possible to store up to 50 chaser effects with up to 99 steps each. There are three different kind of chase programs regarding the way of setting the steps:

ON-OFF Chase:

on each step a selection of channels is switched on to 100%.

REAL-LEVEL Chase:

the brightness of the single channels can be freely adjusted per step.

MEMORY Chase:

each step recalls one of the stored memories.

Chases can be recalled via the special chaser section right hand on the master board or can be loaded to one of the memory master faders 13 to 16. This way up to 5 chaser programs can run simultaneously with individual speed.

Slow fades between the single steps are only possible when running a program on the chaser section.

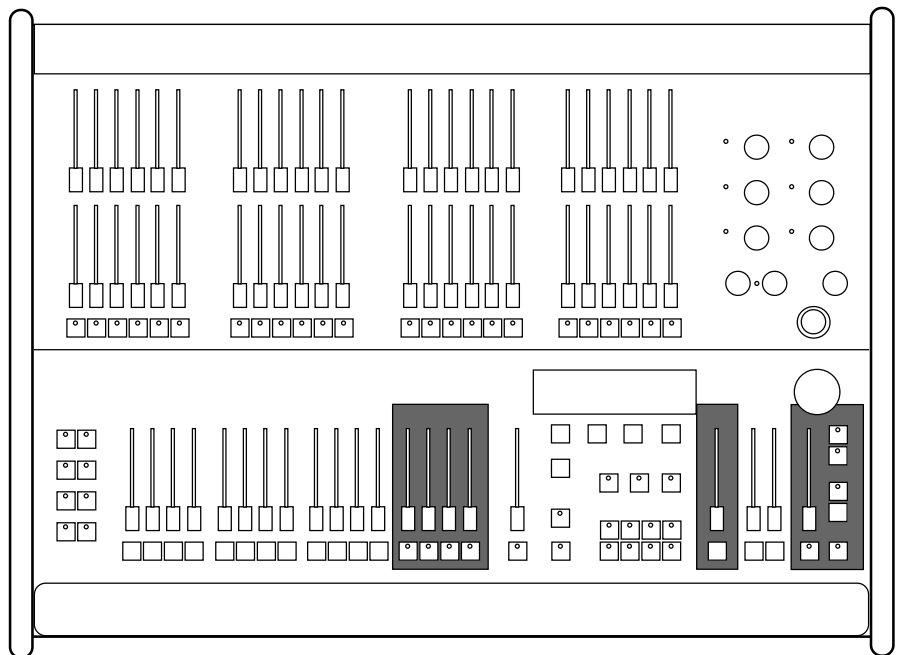

3.1 Programming ON-OFF Chases

All chaser programs have to be stored step by step.

1.  **PRG CHASE/SEQUENCE** The second display button on Top Menu switches to "PROGRAMMING CHASE-SEQUENCE"

2. Selecting a program number via the Encoder wheel. 3. CHASE button. Selecting the chase mode. The box in front of ON/OFF has to be marked.

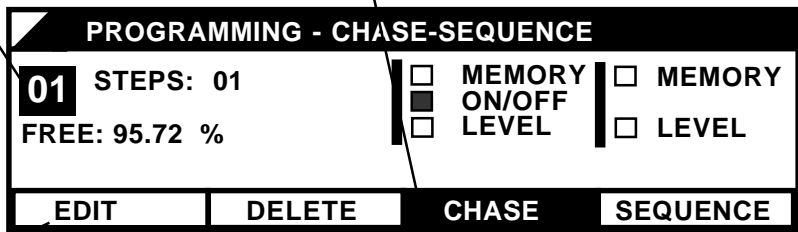

4. EDIT button: leads to programming the single steps.

The LED's within the single channel buttons no longer display the output but will only show the setting of the actual step. To see the steps on stage, the BLIND button right underneath the display has to be switched off.

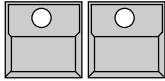
5.  The Flash buttons select channels to be full on for the actual step. AUX-channels can be selected by turning the potentiometer.

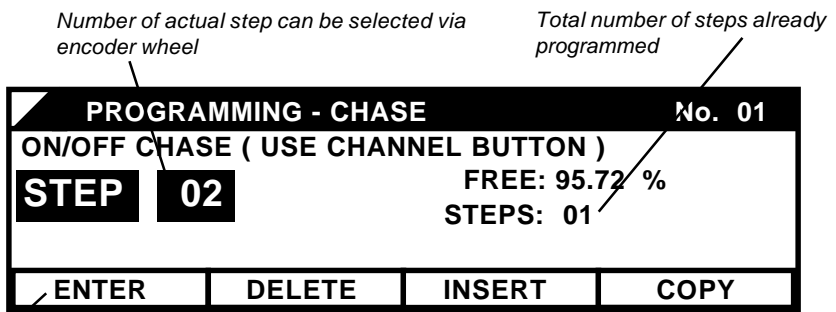

6. ENTER: Stores the channel selection as one step of the chaser program. Going on with setting channels and Enter will add additional steps.

7. The QUIT button switches back to the TOP MENU.

3.2 Programming Real-Level Chases

On Real-Level Chases the single channels can have freely adjusted values for each step. Programming works like with the ON-OFF chases but LEVEL has to be selected via the CHASE button.

If the selected program number was already used by any other chase, changing the chase mode to LEVEL will clear the old program. If the mode was changed accidentally, selecting the "NO" button will cancel the operation and keep the old program.

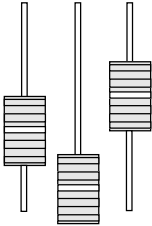
1.
2.
3. Selecting "LEVEL"
4.
5. 
6.
7.

MEMORY
 ON/OFF
 LEVEL

MEMORY
 LEVEL

CHASE

SEQUENCE

The brightness of the single channels can be set by the Preset 2 faders. Again ENTER will store the steps.

3.3 Programming Memory Chases

Already programmed memories can be linked together to run as a chase.

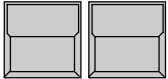
1.
2.
3. Selecting "MEMORY"
4.
5.  ...
6.
7.

MEMORY
 ON/OFF
 LEVEL

MEMORY
 LEVEL

CHASE

SEQUENCE

The memories are selected via their Flash buttons. The number and page is shown in the display.

For further informations see:

Explanations on the display

Test and modification of stored chaser programs

- s.6.5

- s.6.5 and 6.7

3.4 Recalling a Chase

Chases can be controlled via the special chaser section right hand of the main master fader.



"Number"-button

The upper section of the display shows program number and step of the actually running chaser program. Via the Encoder a new program number can be preselected as NEXT :....



"ON"-button

starts the "NEXT" chaser program.

"OFF"-button

stops the actual chase.

The brightness of this chaser effect can be mastered by the chaser master fader.

3.5 Controlling the Speed of a Running Chase



"Speed" button within the Chaser section switches to the "CHASER SPEED" menu.

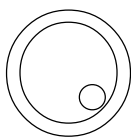

The rate of the chaser is shown in Hertz (steps per second) and as real step time in seconds. It can be set via the Encoder or by the LEARN button.

CHASER SPEED		No. 01	
2.12 Hz	FADE 00%	RUN: 0.00 Sec	
0.47 Sec		SOUND/MANUAL: 0.00 Sec	
FADETIME	<input type="checkbox"/> REVERSE	<input type="checkbox"/> SINGLE	
LEARN	SOUND	FREE RUN	SWAP

Direct input of the chaser speed by pushing the button in time to the music.

Incoming sound triggers the chase

Chase runs with adjusted speed. Without FREE RUN or SOUND selected, only the STEP button will switch the chase to the next step.

Alters the function of the display buttons to FADE-TIME - REVERSE - SINGLE.





The adjusted speed, the mode and the fadetime is stored together with the chase number.

3.6 Controlling the Fade between Chase Steps

The change between steps of a chase can be performed as switching to the new values or as a slow fade. The fade functions gets activated by the FADE button in the chaser section.

On the Lightcommander II any fade will work as a dipless crossfade. A single channel i.e., which is at 100% in the first and at 80% in the second step, will not fade down and come up again, but will fade linearly from 100 to 80%.

The speed of the crossfade is set in the Speed Menu.

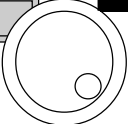
1.  "Speed" button at the chaser section switches to the menu "CHASER SPEED"
2.   4. Display button SWAP Changes the function of the display buttons to control the FADETIME and the running direction.
3.   As long as the FADETIME button is pushed, the Encoder can be used to set the time.
4. 

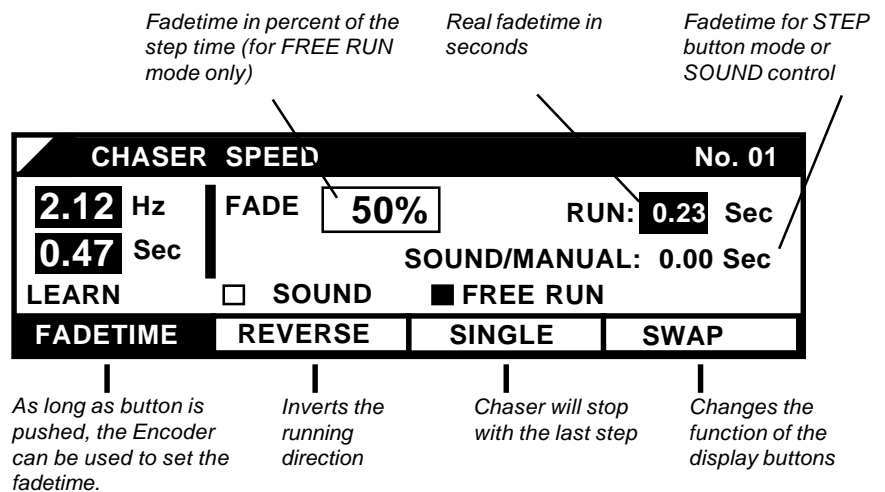



When using FREE RUN mode, the Fadetime gets adjusted in percent of the step time. Changing the speed of the chase will automatically adapt the fadetime.

In case FREE RUN is switched off and the steps are recalled by sound signal or the Step button, the fadetime is set in seconds.

3.7 Chases on Memory Faders

The four memory faders 13-16 can be used to recall chases. One single program may even be recalled several times with different speed. The actual chaser speed is indicated by the LED in the memory button.

1.  **CHASE TO MEMORY** The 3.Display button at the Top Menu switches to "CHASE TO MEMORY".
2.  Selection of one of the Memories 13-16 by its Flash button. The display shows, whether there is already a chase linked to this memory.

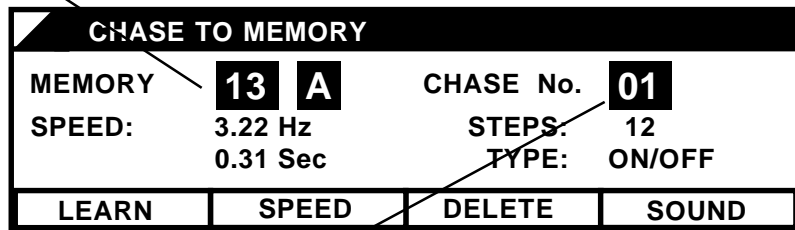

Direct input of the speed by pushing the button in time to the music.

While SPEED button is pressed, the Encoder changes the speed.

Clears the link and the fader will return to control the static memory.

Incoming sound signal triggers the chase.

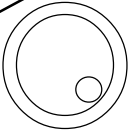
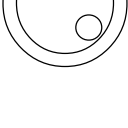
3.  Using the Encoder will select a chaser program number. The channel LED's show the chase running with the selected speed.
4.  While the SPEED button is pressed, the Encoder changes the chaser speed.
5. Quit returns the desk to the Top Menu.

4. Dipless Crossfade (X-Fade)

Right hand of the memory master faders the Lightcommander offers a special X-Fade section for dipless crossfades between stage scenes. Unlike the effect of changing from one memory to another by moving up or down the faders, on dipless X-fades any channel changes linearly to its new value.

Selecting the working mode (SETUP)

At the setup it can be chosen whether the scenes get selected by their buttons or whether the X-Fade runs one of the stored programs.



2 x pressing the "X-Fade menu" button underneath the QUIT button switches the board to the X-Fade Setup Menu.

Number, length and type of the selected program

X - FADE SETUP			
<input checked="" type="checkbox"/> DIRECT MEMORY	<input checked="" type="checkbox"/> MEMORY	<input type="text" value="--"/>	-- STEPS
<input type="checkbox"/> PREPARE MEMORY	<input type="checkbox"/> CHASE	TYP: -----	
<input type="checkbox"/> SEQUENCE	<input type="checkbox"/> TIMED SEQUENCE		
SELECT	SELECT		REC.FADE

"DIRECT": selecting a memory by its button starts the X-fade immediately.

"PREPARE": the X-fade will not start before the GO button is pressed

Selection of the working mode

Stores the adjusted fade time per steps resp. times the manual fade

X-fade working menu:



"X-Fade On/Off" button starts the X-fade mode. If the X-fade is already on, the "X-fade Menu" button toggles between the two menus.

X - FADE		MEMORY		NEXT: -- A	
<input type="text" value="--"/> A	<input type="text" value="2.25"/>	<input type="text" value="--"/> A	<input type="text" value="2.25"/>		
OUTFADE	INFAD			NEXT	MANUAL

Actual stage scene

New picture, ready to fade in

Next picture, if already prepared

Outfade time of the actual scene

Infade time of the new picture

s.6.7 Changing the order of preprogrammed X-fade shows

Toggles between automatic and manual fade

Terminating the X-fade mode:

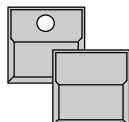

As long as the "X-Fade On/Off" button is held down, the display offers two new functions.



FADE OFF: the next fade will clear the X-fade

SWITCH OFF: terminates the X-fade mode immediately

4.1 Automatic Crossfade between Memories

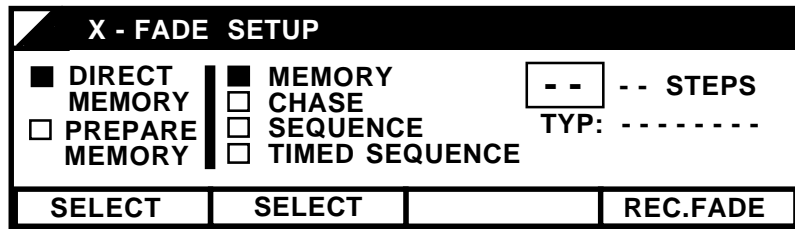
1.  2 x "X-Fade Menu" button switches to the Setup.



2.  Select "DIRECT MEMORY" and "MEMORY" via the first two display buttons
3.  "X-Fade On/Off" button starts the X-fade mode

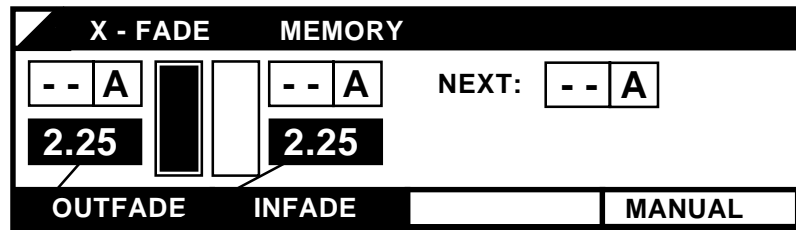

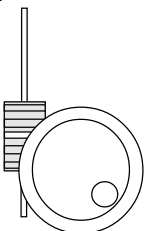
4.  Times, selected by the display button, are displayed on black background and can be altered via encoder or the fader in the X-fade section. The fader works in grap mode, e.g. as soon as it reaches the actual value, it will take over control

5.  When recalling memories by their buttons, the desk will fade to the new picture. Even during running fades the times can still be modified.

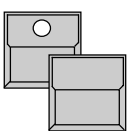
6.  While the "X-Fade On/Off" button is held down, the X-fade mode can be terminated by the display buttons SWITCH OFF or FADE OFF.

Outfade time of the actual stage scene

Infade time of the new picture

S. 4.2 (has to be switched off)

4.2 Manual Crossfades between Memories

Instead of fading automatically with adjusted times it is possible to fade manually by moving the X-fader

1. ...
2. ... like on automatic mode
3. ...

- 3a.  Selecting MANUAL (4th display button)

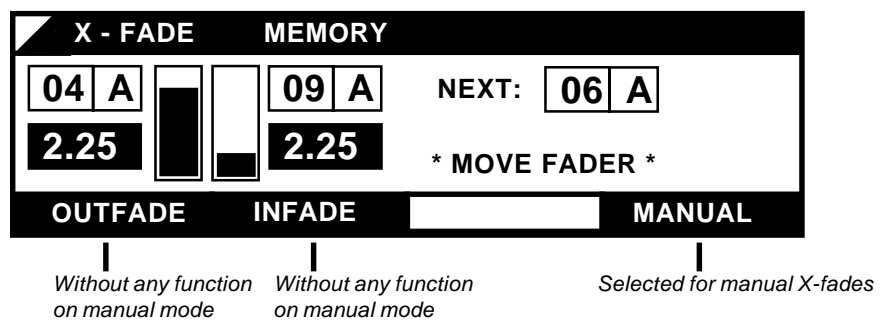

4.  Memories get selected by their flash buttons and displayed as NEXT: ...

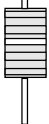
5.  Starting from the lower or upper end of the travel, the crossfade can be done manually via the X-fader. As soon as the end of the travel is reached, NEXT will be loaded to be the INFADE.

The NEXT memory can already be selected before the last fade was finished. The preselected memory will automatically be downloaded at the end of the travel.

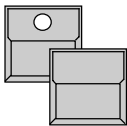
6.  Holding "X-Fade On/Off" down and selecting SWITCH OFF in the display terminates the X-Fade. After FADE OFF the next fader travel will manually fade off.

*For further informations see:
X-Fade with preprogrammed scene order*

- 5. Sequences

4.3 X-Fading a Chaser Program

The steps of any chase can be recalled on the sequence section. Adjusting fade times or fading manually works similar like on selecting the scenes via the memory buttons.

The LED within the GO button lites as long as the X-fade runs. After finishing the fading the LED goes out.

1.  2 x "X-Fade Menu" button

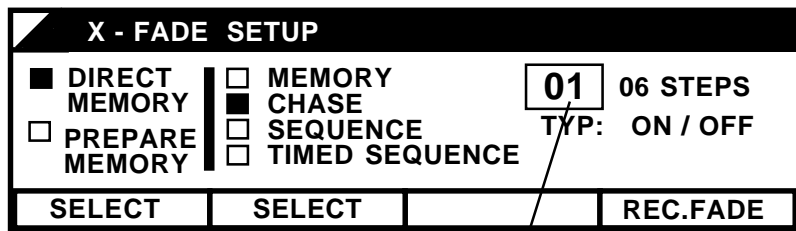

2a. |
Selecting
"CHASE"

2b. |
Selecting a chase
program number
via encoder

3.  "X-Fade On/Off" button starts the X-fade mode

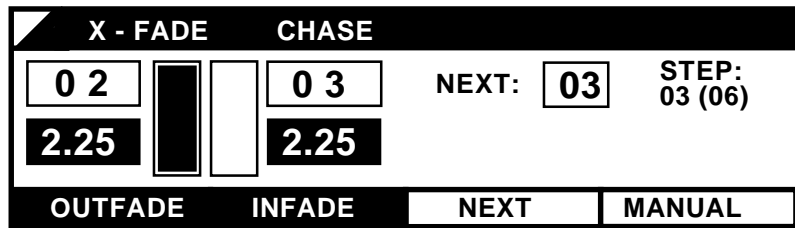

Outfade time of the
actual scene

Infade time of the
new picture

Toggles to manual
fade mode

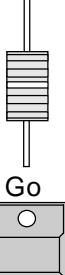
- 4a.  Automatic mode:
The GO button
starts the X-fade
with adjusted times

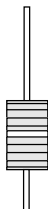
- 4b.  Manual mode:
By moving up and
down the fader the
scenes are recalled
manually

For further informations see:
Inserting a memory within the chaser steps
Returning to the last step

- 6.7.3 Modifications of step order
- 6.7.3

5. Preprogrammed Lighting Shows (Sequences)

Beside the chaser programs there are another 50 sequence programs to be stored and recalled on the X-fade section exclusively. Compared to the chaser programs this sequences may have preprogrammed times per step and may recall a chase as one of the steps.

5.1 Programming Sequences

1.  **PRG CHASE SEQUENCE** The menu allows to select another 50 program numbers marked as sequences.
2. Selecting SEQUENCE and a program number. Analog to programming chasers, MEMORY and REAL LEVEL sequences are selectable.

PROGRAMMING CHASE - SEQUENCE			
01	STEPS: 00	<input type="checkbox"/> MEMORY ON/OFF LEVEL	<input type="checkbox"/> MEMORY <input checked="" type="checkbox"/> LEVEL
FREE: 95.72 %			
EDIT	DELETE	CHASE	SEQUENCE

3. EDIT leads on to programming the single steps.
4. Depending on the selected type the steps are created by selecting a memory or preparing the scene with the preset 2 faders.

PROGRAMMING - SEQUENCE		No. 01
USE PRESET 2		
STEP 01	FREE: 95.72 %	STEPS: 00
INFADE 0.50 SEC	OUTFADE 0.50 SEC	
ENTER	DELETE	INSERT COPY

5. ENTER stores the step and toggles to the second menu.

PROGRAMMING - SEQUENCE		No. 01
STEP 01	1.75 Sec	1.00 Sec
		CHASE 06 LINKED
ENTER	INFADE	OUTFADE LINK

6. Fade times can be selected via their button and adjusted by the encoder.
7. As long the LINK button is held down, the encoder sets a chaser program number. Turning to "0" unlinks the chase.
8. ENTER stores the fade times and the linked chase and goes on to programming the next step.

For further informations see:

Including memories as Real Level Step- 6.5 Modifying chaser or sequence steps

Saving the output as Real Level Step - 6.5

Working with Theatre Sequence - 7.2.3

5.2 Recalling Sequences

1.  2 x "X-Fade Menu" button.

- 2a. Selection of SEQUENCE (preprogrammed times get ignored) or TIMED SEQUENCE (program will recall the preprogrammed fade times)

- 2b. Selecting a sequence program number via encoder.

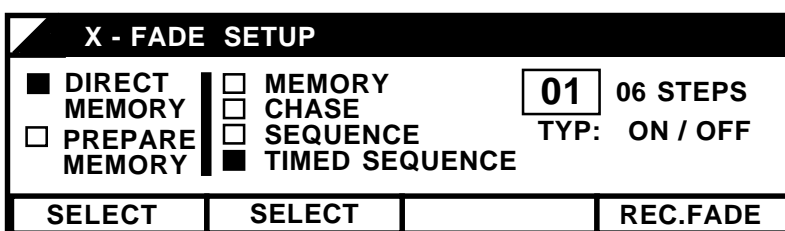

3.  "X-Fade On/Off" button start the X-fade mode.

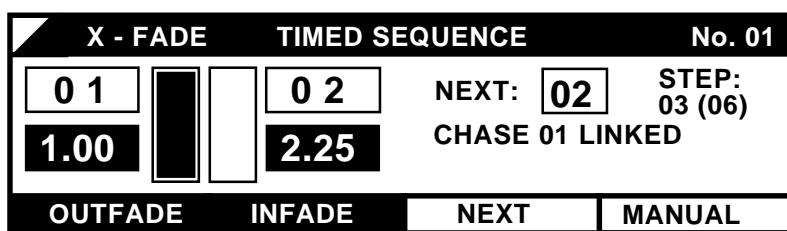

- 4a.  The sequence can be recalled manually via the fader or automatically via the GO button. If TIMED SEQUENCE was selected, the preprogrammed fade times get recalled for each step, but can still be modified.

A chase, linked to a sequence step, will be listed in the display before it starts. As soon as the sequence step starts, the board cancels the chase, which is actually running at the chaser section and will load and start the linked chase. The brightness of the chase is fading in and out together with the brightness of the sequence step. As long as the sequence controls the chase, the LED in the chaser ON button blinks. To cancel or control the chase independently from the sequence step, it has to be restarted with the ON button. This way the brightness of the chase returns to be controlled via the chase fader.

For further informations see:

Inserting a memory into the sequence step order

Returning to the previous step

Testing and modifying a running sequence

- 6.7.3 *Modifying the step order*

- 6.7.3

- 6.7.1 and 6.7.2

6. Preview and Modifying

Any program of the Lightcommander can be previewed and modified before it comes to stage. The actual output values can be listed in percentage and the Limit function enables to reduce the overall brightness of any channel.

6.1 BLIND Function

During programming, previewing or modifying, the channel LED's no longer show the output intensity, but show the contents of the selected program.

During "PROGRAMMING MEMORY" they show preset 2 intensity only. This enables to program memories blind by setting the preset 2 master to zero and selecting "SAVE PRESET 2" for saving the memory.



BLIND button right under the display switched on:
The program, indicated on the LED's, is not transmitted to stage.



BLIND button switched off:
The indicated program will be send to stage, even with main master at zero. During Softpatch operations the selected dimmer number gets switched on.

If BLIND is switched off, the Top Menu shows a "LIVE" warning. Recalling the preview function will automatically activate the BLIND function.

6.2 PREVIEW - Output Listing



The PREVIEW button underneath the display lists the actual output values in percentage. As Preview also starts the testing of memories, the memory buttons are not longer switching on the memories but just select them for previewing.

ATTENTION !

Channel number, A1-A6
indicates the AUX channels

Actual output value
(FF=100%)

01	-	07	FF	13	-	19	-	25	-	31	-	37	-	43	-	A1	-
02	45	08	FF	14	-	20	-	26	-	32	-	38	-	44	-	A2	-
03	62	09	-	15	-	21	-	27	-	33	-	39	-	45	-	A3	-
04	-	10	12	16	-	22	-	28	-	34	-	40	-	46	-	A4	-
05	-	11	03	17	-	23	-	29	-	35	-	41	-	47	-	A5	-
06	-	12	-	18	-	24	-	30	-	36	-	42	-	48	-	A6	-
LIMIT			SELECT MEMORY						X-FADE								

See 6.3
Output limit

See 7 preview and modifying
sequence steps

6.3 Output Limit

1.  Press the PREVIEW button

2.  **LIMIT** First button toggles to the Limit function. The LED's of all channels, which got a reduction yet, lit up. The display lists the limitations whereas FF=100% means, that there is no reduction on this channel.

Channels with numbers displayed on black background can be altered by the encoder or the first two display buttons

01	FF	07	FF	13	FF	19	FF	25	FF	31	FF	37	FF	43	FF	A1	FF
02	-	08	FF	14	FF	20	FF	26	FF	32	FF	38	FF	44	FF	A2	FF
03	62	09	FF	15	FF	21	87	27	FF	33	FF	39	FF	45	FF	A3	FF
04	FF	10	FF	16	FF	22	87	28	FF	34	FF	40	FF	46	FF	A4	FF
05	FF	11	FF	17	FF	23	87	29	FF	35	FF	41	FF	47	FF	A5	FF
06	FF	12	FF	18	FF	24	FF	30	FF	36	FF	42	FF	48	FF	A6	FF
100 %				0 % OFF				ALL 100 %									

Sets all selected channels to 100%

Clears the output for the selected channel

Cancels all reductions for all channels.

Limiting single channels:

3a.  Single channel buttons
Selecting of one or more channels. The numbers of these channels get displayed inverted.

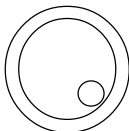
3b.  The encoder wheel or one of the first two display buttons changes all selected channels simultaneously. Limitations work on line on the actual output.

or:

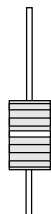



Single channel faders of preset 2:

The reduction can also be set via the faders of preset 2. The fader will take over control as soon as it reaches the actual value (Grap mode). To do a limitation via preset 2 without effect to the stage the preset 2 master has to be at zero.

4. The PREVIEW or QUIT button returns the board to the Top Menu. Any limitation gets indicated by the warning "OUTPUT LIMIT".

6.4 Previewing and Modification of Memories

Previewing a memory:

1.  PREVIEW button
2.  Any memory flash button
The LED's show the channel values as stored in the memory. The display lists these values in percentage.

Selected channel with numbers on black background can be modified via encoder.

01	-	07	FF	13	-	19	-	25	-	31	-	37	-	43	-	A1	-
02	45	08	FF	14	-	20	-	26	-	32	-	38	-	44	-	A2	-
03	62	09	-	15	-	21	-	27	-	33	-	39	-	45	-	A3	-
04	-	10	12	16	-	22	-	28	-	34	-	40	-	46	-	A4	-
05	-	11	03	17	-	23	-	29	-	35	-	41	-	47	-	A5	-
06	-	12	-	18	-	24	-	30	-	36	-	42	-	48	-	A6	-
MODIFY MEMORY:										5		A					

Modifying single channel values during preview:

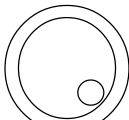
- 3a.  Channel button
Selected channels get displayed on black background
- 3b.  Encoder wheel right hand of the display
Changes all selected channels simultaneously. Any modification changes the stored memory directly, even if it actually is on stage.

or:



Faders of preset 2

The channel values of the memory can also be modified via the faders of preset 2. The fader will start to modify the channel as soon as it has reached the stored value (Grap mode). To modify a scene without effect to the stage, the preset 2 master fader has to be at zero.

4. PREVIEW or QUIT returns the board to the Top Menu
Any modification changes the stored memory data directly. In case the memory is active on stage, the modification influences the stage too.

ATTENTION!!

6.5 Modifying Chase or Sequence Steps

- PRG CHASE SEQUENCE
- CHASE or SEQUENCE
- Selection of the program number via encoder
- EDIT Selecting of the program like on programming

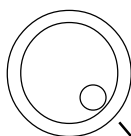

Turning the encoder recalls the step to be shown on the LED's. If BLIND is switched off, the steps can be seen on stage.

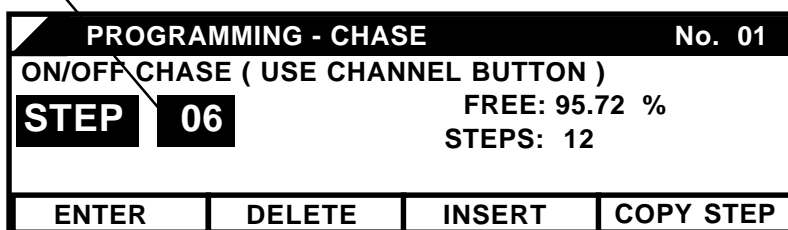

Modifying single steps (Overwrite):

Depending on the type of program the steps get modified via the single channel buttons (ON/OFF), the preset 2 faders working on Grap Mode (REAL LEVEL) or the memory flash buttons (MEMORY). ENTER saves the modified step. Selecting a new step via encoder without using ENTER will cancel the modification.

Deleting the selected step: - DELETE button on the display

Creating a new step at the selected step address: - INSERT button

Copying the selected step

- COPY button (all squares are now displayed on black background)
- Selecting a new step address via encoder
- ENTER: Overwrites the selected step by the copy
- INSERT: Inserts the copy at the selected address as a new step
- CANCEL: Clears the copy storage and the desk returns -as also by ENTER and INSERT- to the starting-point

Transferring the output value to a REAL LEVEL sequence step (not possible within the BLIND mode):

The actual output values of sequences, created by memories, chasers or preset faders, can be copied as LEVEL step.

- Recalling one or more memories via the fader + pushing the COPY button transfer the values of the memory together with the values of the actual step into the copy storage. Every further pushing of the copy button adds the output to the copy storage.
- ENTER, INSERT, CANCEL see above.

6.6 Previewing a Chase

6.6.1 Preview at the Chaser Section

Chases store the speed and fade time of their last recall. Before starting with the ON button, the program and its times can be previewed and modified.

The NUMBER button on the chaser section enables to preselect a new chaser program number via encoder.

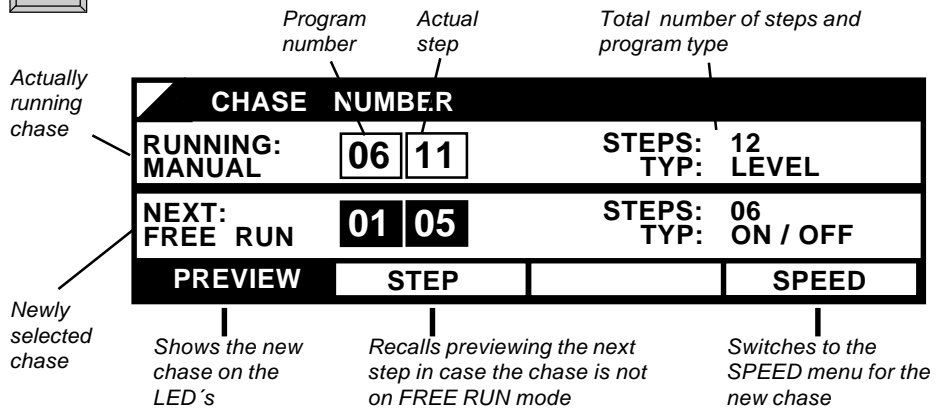

Selecting PREVIEW (displayed on black background) shows the new chase with its speed on the LED's. Selecting SPEED enables to change the speed before starting the chase.

6.6.2 Preview a Chase on Memory



"PREVIEW" button



Flash button of a memory 13-16, which contains a chase. The chase is shown on the channel LED's.

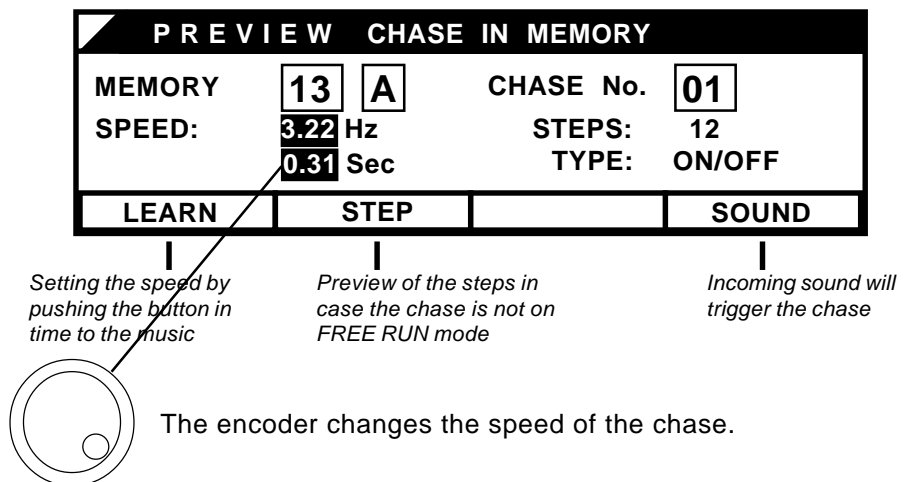

6.6.3 Previewing a Chase linked to a Sequence Step

Even chases, linked to a sequence step, can be previewed (see 6.7.1)

6.7 Preview and Modifying a running X-Fade

In case a chase or sequence is loaded to the X-fade section, the actual and following steps can be previewed and modified. Beside changing single channels intensity it is possible to change the order of the scenes or to insert a memory.

6.7.1 Preview on the following X-fade Steps



PREVIEW button
The GO button still recalls the next picture while the display lists the output values.



X-FADE

By selecting the fourth display button, the display will change to show the values of the actual or infading step of the X-fade.



CHASE -

If there is a chase linked to one of the steps, the fourth display button allows to swop to the speed menu of this chase.

6.7.2 Modifying X-Fade Steps

By using PREVIEW - X-FADE the intensity of the single channels can be modified for any of the steps.

Modifying REAL LEVEL steps:

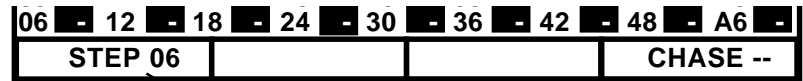

Selecting the step by pressing the STEP button and selecting the step via encoder

Channels, selected by their buttons, can be modified via the encoder or preset 2 faders may be used in Grap Mode.

Modifying MEMORY steps:



As the modification will not only affect this step, but will change the stored memory, MODIFY has to be switched on first. Modifying works like on LEVEL steps.

As long as the MEM... button is held down, the memory can be substituted by another memory number.

Modifying ON/OFF steps:

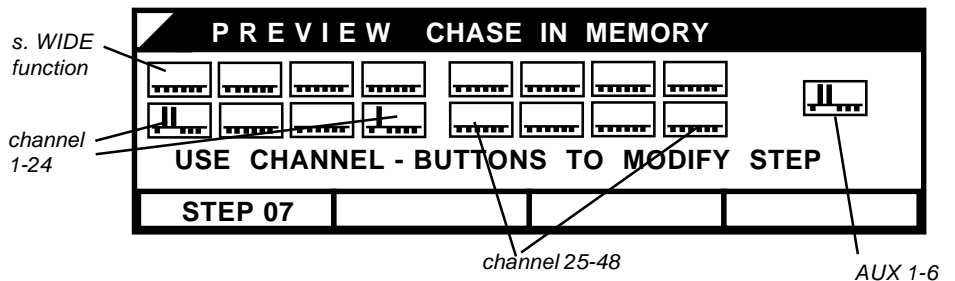

ON/OFF steps are displayed by a display graphic and on the channel LED's. Modifications can be done using the channel flash buttons.

6.7.3 Changing X-Fade Scene Order

When recalling chase or sequence programs via the X-fade section, the scenes are recalled step by step as set in the program. This order can be changed using the NEXT- or the GO-Minus function.

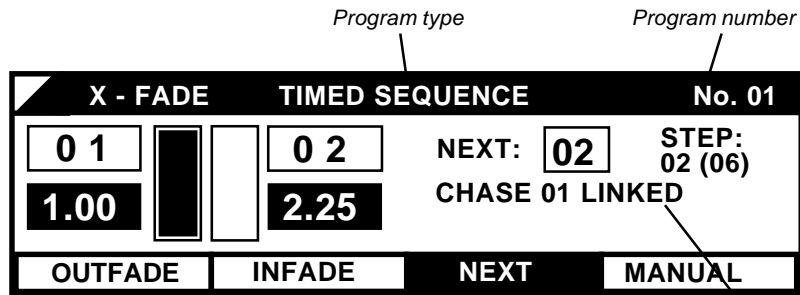

Informations on linked chases

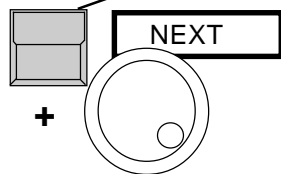

While holding down the NEXT button a new step can be selected by using the encoder. The next fade will go to the newly selected step number.

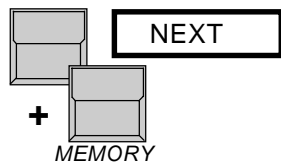

Holding down the NEXT button and selecting a memory button inserts this memory within the scene following.



As long as the "X-Fade On/Off" button is hold down, the display shows the X-fade Off menu. *Number of the step to be recalled by Go-Minus*

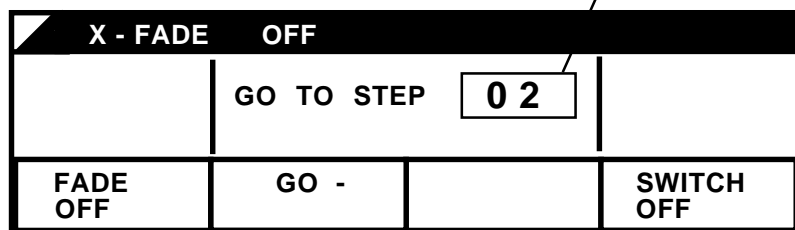

The next fade terminates the X-fade mode

Starts the fade to the previous step

Switches off the X-fade mode



The "GO-" button starts the fade to the previous step. (This only works on automatic mode).

7. Special Functions

The UTILITY/SETUP menus of the Lightcommander offer various special functions and setup facilities.

7.1 Single Channel Setups

7.1.1 Doubling the Channel Number (WIDE Function)

One of the most interesting features of software version 2.X is the possibility to double the number of channels. This way the Lightcommander II 24/6 offers $24+24+6=54$ channels (LC II 48/6: $48+48+6=102$). All functions work as usually, only on using the preset section there are some little changes.

Switching on the WIDE function:



**UTILITY/
SETUP**

Fourth display button on the Top Menu



SETUP

First display button to select the functions
CLOCK - WIDE - SPECIALS - THEATRESEQ.



WIDE

Selecting WIDE (now displayed on black background) modifies the operation mode:

Single channel faders

The faders of preset 2 still control the same channels, while the faders of preset 1 work as an extension of preset 2 and control a second set of channels.

Preset master brightness

The overall brightness of the adjustment on all preset faders is mastered by the preset 2 master fader only.

Single channel flash buttons and LED's:

As there is only one set of buttons and LED's, only half of the channels are indicated and possible to access by button at time. The preset 1 master after toggles the buttons between the two sets of channels.

Preset 1 master above 50 %: The buttons indicate and control the upper channels.

Preset 1 master below 50 %: The buttons indicate and control the lower set of channels. A double arrow on the right edge of the display shows the actually selected orientation of the buttons.

Channel value listing during PREVIEW and LIMIT:

The Lightcommander 24/6 shows the second set of channels as channel number 25 to 48.

The Lightcommander 48/6 shows, depending on the preset 1 master setting, only the upper or the lower set of channels on display.

Graphics (like on PREVIEW ON/OFF step, SWOP DISABLE or CURVE) show the complete set of channels.



Internally the WIDE function is always working. Memories or programs, set up under the wide function, will control the extended channel range even if the WIDE function was switched off later on.

ATTENTION !

7.1.2 Connection Desk Channel to Dimmer Channel (Soft-patch)

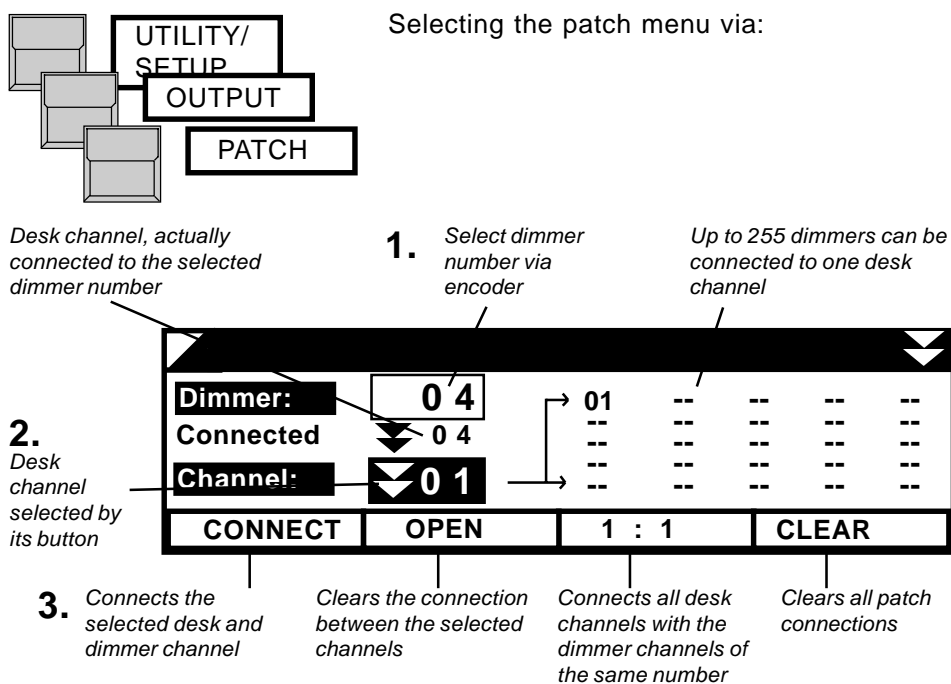
The channels of the Lightcommander represented by the numbers under the flash buttons can be freely patched to the dimmer channel numbers. Any desk channel may control several dimmer channels simultaneously whereas the other way round the dimmer channel can only listen to the control commands of one single desk channel.

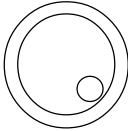

1.  Selection of a desk channel by its button. On WIDE mode preset 1 master toggles between the upper and lower channel set.
2.  The encoder selects a dimmer number. Maximum dimmer address on the Lightcommander is 256.
 - 2a.  To identify the dimmer number on stage, the selected dimmer is set to 80 % if the BLIND function is switched off.
3.  **CONNECT** patches the selected desk channel to the selected dimmer address. Any former connection of this dimmer is cancelled automatically.

QUIT returns the desk to the Top Menu.

The Lightcommander 24/6 (48/6) features 0 to +10V DC analog output of the first 30 (52) dimmer channels on Socapex EF337.

The complete range of dimmer channel 1-256 is available via DMX 512 (1990).



During WIDE operation the patch command "1 : 1" will patch the AUX channels at the end of the standard channel range (LC24: 49-54, LC48: 97-102).

7.1.3 Dimmer Curve

Standard dimmerpacks usually show an non-linear increase on brightness when moving up the channel fader. By choosing a special non-linear output modulation this effect can be compensated. Therefore all channels which are supposed to control dimmer channels have to be set to "CURVE" on the Lightcommanders setup menu.

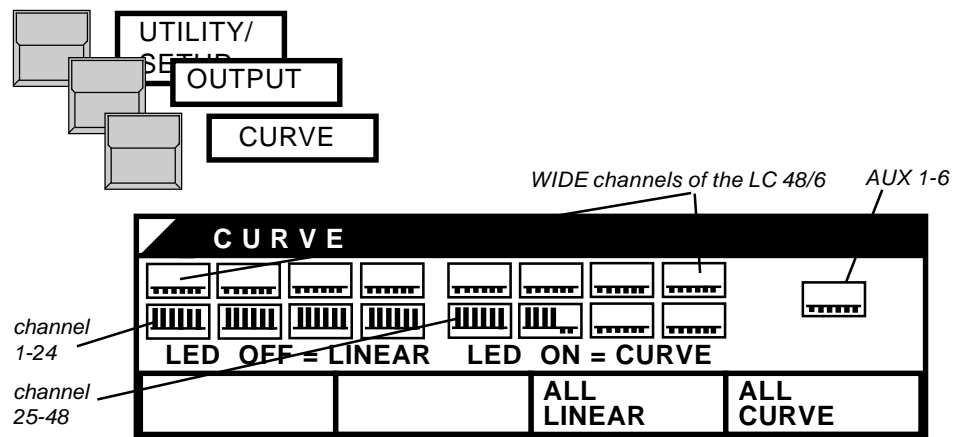

For all channels set to CURVE, the LED will lit up and the graphics show a bar upward. Changes can be done via the channel buttons. Color scrollers and effects should be controlled with LINEAR setting.

7.1.4 Swop Disable

When using the SWOP effect (see 1.2), channels which control color scrollers or effects should not be set to zero. For these channels the Swop effect can be disabled.

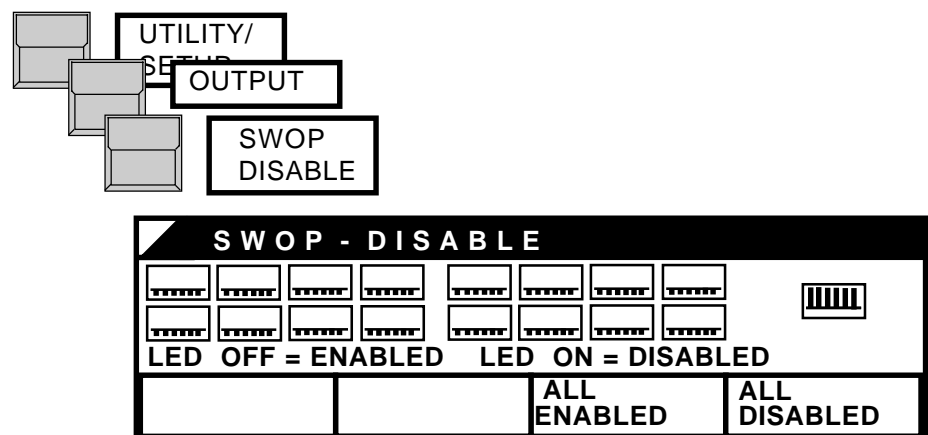

On channels which are protected against the Swop effect the LED is on and the graphic shows a bar upward. Changes can be done via the channel buttons.

7.2 Changing Board Operation Mode

7.2.1 Switch Memories

Especially for working with color scrollers or multi-functional fixtures it is possible to change the operation mode of the Switch Memories (see 2.3)

FLASH mode: The memory is on stage as long as the button is held down. When using with Swop effect all other signals get erased during this time.

TOGGLE mode: The memory gets switched on by pushing the button. It stays on stage and its LED stays on until the button is pressed a second time.

The values of these TOGGLE memories are independent from main master or blackout DBO and are not killed by the SWOP effect. During X-fade operation mode on memories the TOGGLE memories work independently. They can be switched on without affecting the running X-fade.

KILL mode: Works as the TOGGLE mode, but selecting a new KILL memory automatically clears the older one.

The Switch Memory mode gets selected via

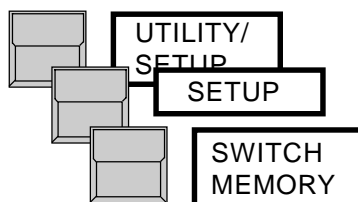

7.2.2 Keyswitch

All programs within the Lightcommander can be protected against overwriting or clearing.

<u>Key position:</u>	<u>Function</u>
ALL ACCESS	Access to all desk functions
LOCK PROGRAMMING	All programming functions are locked. During PREVIEW mode the values can not be changed. Only the speed parameters of the chases can be adjusted.
LOCK DESK	The desk does not react to any operation on the front panel. Running chases or remote programs via MIDI (see 8.2) go on working.

7.2.3. Theatre Sequence

There are two special modi for Theatre Sequences available with only a little difference. In general every sequence receives within both modi a step name consisting of numbers instead of a step number. This name will be unchanged while inserting or deleting steps. So step 1. 1 will be created by inserting a new step between step 1 and 2.

Especially in theatre this is the usual mode to insert or delete additional steps without changing the whole concept.

The Theatre Mode is selected resp. shifted by pushing

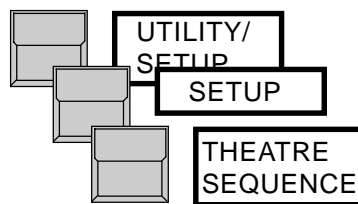

IMPORTANT !

Selecting this mode all previous sequences were deleted after an additional enquiry.

Therefore it is absolutely necessary to choose either the theatre sequence or the "normal" sequence before programming the desk!

At any time it is possible to switch between mode 1 and 2 without data getting lost. To switch from mode 2 back to mode 1, answer "NO" to the enquiry "are you sure?". So also the sequences are not lost.

The sequences in mode 1 are programmed in the same way as described in Chapter 5 (p. 23).

In mode 2 either the actual output (LIVE) or the actual step (BLIND) will be stored.

Firstly the full step name is given (for example 1.0, 2.0, 3.0...); this name can later be changed within the second PROGRAMMING SEQUENCE menu (after pushing ENTER once) after turning off INFAD and OUTFADE.

Without changing the step name there is a standard step distance of 1.0. Therefore nine steps (X.1 to X.9) can be inserted; this is done automatically by INSERT. Because changes can be made only within the previous and following step, a rising order appears.

7.3 Backup on Cue Cards

The complete programs of the Lightcommander can be saved to cue cards (ITT CANNON - STAR CARD CSC-0032K-SM-3II or compatible ones).

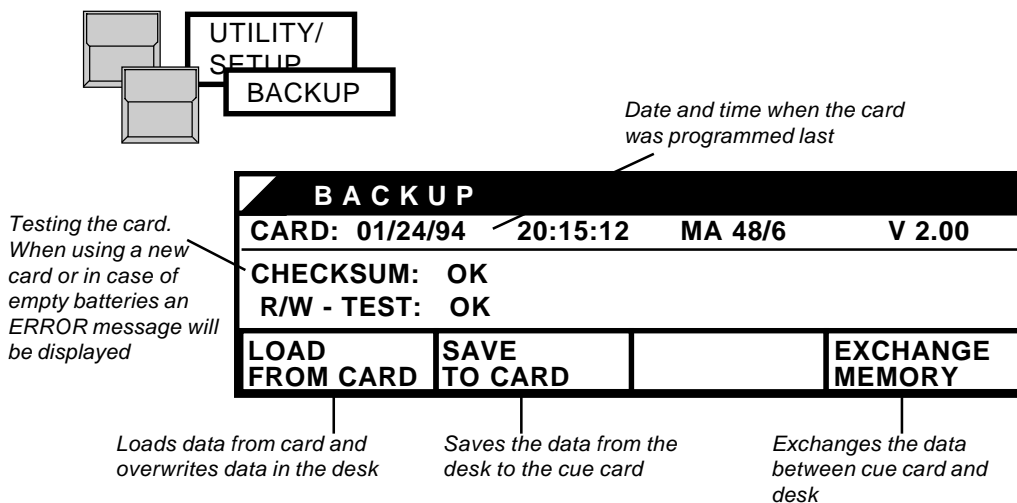

ATTENTION: The cue cards work with a battery which has to be mounted before the first use. Average lifetime of these batteries is two years. Note the date of inserting the battery on the backside of the card and exchange the battery in time, otherwise all programs on card get lost.

Change battery only while card is inserted - the card is supplied meanwhile by the desk. All shows will get lost, when you remove the battery from the card, while the card is not inserted in the desk.

Insert the card in the desk. Release the locking device of the Battery carrier and remove only the battery carrier. Attach a new battery to the carrier (pay attention to the polarity + / -) and insert the carrier with the new battery in the card. Move the locking device in direction of the arrow ("Lock")

The type of battery varies from manufacturer to manufacturer - whether you find a type identification on the card or remove the battery - while card is inserted - and identify the type of battery.

Please remove the card from the desk as long as the card is not in use.

IMPORTANT !

7.4 CLEAR ALL Programs on the Desk

When starting with a new show all programs of the Lightcommander can be cleared completely by one single operation. All four display buttons have to be held down when switching on the desk. After confirmation by "YES" the board will clear all programs and special setups and set the softpatch to "1 : 1".

7.5 Automatic Test Routines

Whenever the Lightcommander is switched on it will test all programs and settings. In case there is any memory error, the according section of data has to be cleared by the QUIT button. If this happens repeatedly please contact your MA dealer.

7.6 Adjusting Date And Time

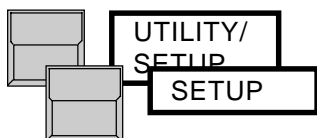

Within the setup menu time and date can be adjusted via encoder

7.7 HOLD Function

The HOLD function will freeze the output of the desk. Changes can then be made on the desk without those changes occurring on the stage. When ready, those changes can be output from the desk by reducing the main master to 0, and then back to 100 %.

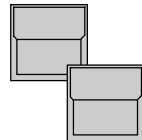

Select the HOLD menu by pressing and holding the QUIT button

HOLD

The HOLD button freezes the output.

Now all changes on the desk can be made "invisibly". When you are ready, the new stage scene can be faded in using the main master fader which simultaneously deactivates the HOLD function.



HOLD OFF

By the HOLD OFF button the HOLD function is deactivated immediately.

8. Remote Control and Linking

Via MIDI two Lightcommander II desks can be linked in master-slave operation or a show can be recorded to a MIDI sequencer.

8.1 Master-Slave Operation

On the Master desk all functions will work as usual. On the slave desk only the single channel faders and buttons work. All other functions of the slave are remote controlled by the master desk. Each desk keeps its own output on Socapex and DMX 512. The softpatch is done on both boards separately. To send the control data of both desks to stage on one single DMX cable, the two lines have to be combined via a separate unit, called DMX Merger.

For working with Theatre Sequences, master and slave desks must be set to the same mode before coupling!

1. Switch OFF both desks via the power switch.
2. MIDI OUT of the first desk has to be connected to MIDI IN of the second desk and vice versa. A standard MIDI 5pin cable can be used.

3. Switch on the slave desk first and select

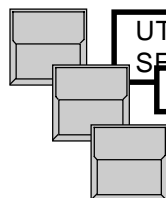

**UTILITY/
SETUP**

EXTERN

SLAVE

The display stops at "Searching for Master"

4. Switching on the master desk starts the communication between the two desks. To allow synchronous operation, the chaser and sequence programs of the Slave desk will be cut down or extended to the step number found in the master board.
5. The master desk always has to be switched OFF and ON last.

8.2 MIDI Functions

The course of a lighting show can be recorded to a MIDI Sequencer and played back later on.

MIDI can also be used to link more than two desks by using the MIDI THRU connector. Compared to the real Master-Slave operation (see 8.1) there are some limitations on using MIDI.

Recording a show to a MIDI Sequencer:

1. MIDI OUT of the Lightcommander has to be connected to the Sequencer input.

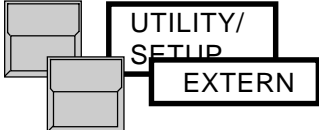
2.  Selecting of the EXTERN Menu

3. **MIDI CHANNEL 06**  Selecting a MIDI channel 1 to 16

4. Switch on RECORD mode at the sequencer

5.  **MIDI OUT** Switch on MIDI OUT at the Lightcommander

6. QUIT returns the desk to the Top Menu.

Because of the limited speed of the MIDI protocol there are some restrictions to the use of the desk while sending MIDI data;

- Single channels are not recorded on MIDI.
- The X-fade can only be used in automatic mode on timed sequences and times can not be changed on-line.

Playback of a MIDI show

1. MIDI IN of the Lightcommander has to be connected to the output of the sequencer.

2. **MIDI IN** Selection of the MIDI channel. MIDI IN has to be switched on.

3. Start the Sequencer.
During playback it is still possible to use the memories or channels of the board. When using the chaser or X-fade section the manual operation will overwrite and cancel the MIDI controlled program (Chaser ON or GO LED is flashing as long as MIDI uses the according section). During MIDI playback programming is locked. For the exact format of used MIDI commands see the following list.

Lightcommander II 24/6 + 48/6 MIDI Codes

The Lightcommander uses Control Change Data exclusively. Within the MIDI menu two different sets of control orders can be chosen, To avoid coincidences, either one or the other can be used.

As soon as MIDI OUT is switched on, all master adjustments and the page are sent as initialization. Chaser and X-fades are stopped.

As soon as MIDI IN is switched on, all internally running memories, chases and X-fades are cancelled. Main and Chaser fader will automatically be set to 100 %.

Commands:

The command 1011nnnn (Bn hex) (nnnn=MIDI channel) will always be sent as status byte.

The following two bytes are data bytes:

<u>Command</u>	<u>1.-</u>	<u>2.Data byte</u>
Memory fader 1	: 00 (102)	+ 00-127 (Fader value)
Memory fader 2	: 01 (103)	+ 00-127 (Fader value)
.	: .	+ . . .
Memory fader 16	: 15 (117)	+ 00-127 (Fader value)
Grand Master fader	: 17 (119)	+ 00-127 (Fader value)
Chaser Master	: 20 (53)	+ 00-127 (Fader value)
Memory button 5-8	: 23 (54)	+ 08=Me.5 04=Me.6 02=Me.7 01=Me.8
Memory button 1-4	: 24 (55)	+ 08=Me.1 04=Me.2 02=Me.3 01=Me.4
Memory button 13-16	: 25 (56)	+ 08=Me.13 04=Me.14 02=Me.15 01=Me.16
Memory button 9-12	: 26 (57)	+ 08=Me.9 04=Me.10 02=Me.11 01=Me.12
Bank A-H	: 27 (58)	+ 00-07 (Bank A-H)
SWOP Blackout	: 28 (59)	+ 16= channel Flash 8=Switch Flash 4= Memory Flash 2=Preset2 Flash 1= Preset1 Flash
DBO	: 29 (60)	+ 00= no DBO 01= DBO Switchmemory Flash 01= DBO Switchmemory Toggle/Kill
Switch Memory 5-8	: 30 (61)	+ 08=SW5 04=SW6 02=SW7 01=SW8
Switch Memory 1-4	: 31 (62)	+ 08=SW1 04=SW2 02=SW3 01=SW4
Chaser ON (+Nr.)	: 32 (63)	+ 00-49 (Chaser number 1-50)
Chaser Step button	: 33 (20)	+ 00-127 (no specific value)
Chaser OFF	: 34 (21)	+ 00-127 (no specific value)
Sequ.ON (+No.)	: 35 (22)	+ 00-49 (Sequence number1-50)
Sequ.Change (+No.)	: 36 (23)	+ 00-49 (Sequence number 1-50)
Sequ.Go	: 37 (24)	+ 00-127 (no specific value)
Sequ.Fadeout	: 38 (25)	+ 00-127 (no specific value)
Sequ.Off	: 39 (26)	+ 00-127 (no specific value)
Init Mem.Bank (intern)	: 40 (27)	+ 00, 4Bit Memory 0-15, 3 Bit Bank 0-7
Init Swh-Bank (intern)	: 41 (28)	+ 00, 4Bit SwitchMem 0-7, 3 Bit Bank 0-7
RESET	: no Status Byte ; 255 (FF)	

Numbers in brackets are the numbers for the alternative controller set.

9. Input and Output

Mains (power supply)

The Lightcommander works without any voltage selection on mains input 90 to 240 V AC (40 to 60 Hz). Input connector and power switch are on the back panel.

Analog output

The analog output signals come out on Socapex EF337 Connectors.

1. Socapex

Pin layout:	Pin 1 - 30	Dimmer 1-30
	Pin 36+37	Common/ground

2. Socapex (only on Lightcommander 48/6)

Pin layout:	Pin 1 - 24	Dimmer 31-54
	Pin 36+37	Common/ground

DMX output

The DMX 512 (1990) output on 5 pin XLR connector corresponds to USITT protocol. All dimmers, demultiplexer, multifunctional fixtures and effects, working on this standard, can be controlled via the Lightcommander.

The output surpasses the RS485 resp. RS 422a standard.

Pin layout:	pin 1 = Common	
	pin 2 = Data -	pin 4 = not used
	pin 3 = Data +	pin 5 = not used

Sound input

The galvanic isolated sound input is a 1/4" jack with 1 kOhm impedance. Minimum voltage of about 100 mV AC is necessary. Input gain is controlled via a LEVEL potentiometer. The HOLD potentiometer allows to set a minimum hold off time of up to 6 seconds between two signals.

MIDI IN / OUT / THRU

On MIDI operations it corresponds to the MIDI standard. On Master-Slave operations a MA specific protocol is used which can not be recorded on a MIDI Sequencer.

IMPORTANT !

All DMX512 and analogue inputs and outputs must be shielded and the shielding must be connected to the ground of the corresponding plug.

If the Socapex output is not in use, please put the enclosed plastic cap on it; so no electrostatic discharging can happen within the plugs.

Index

Symbols

"1 : 1" 34

A

Add - Swop Buttons 8
Adjusting Date And Time 37
ALL ACCESS 36
ALL CURVE 35
ALL LINEAR 35
Automatic Test Routines 37
AUX 1-6 9
AUX-channels 14

B

Backup 37
Battery 37
Blackout 8
BLIND Function 25, 28

C

Changing X-Fade Scene Order 32
Channel LED's 25
Channel Number 33
CHASE button 14
CHASE TO MEMORY 18
Chaser 13
CHASER SPEED 16
Chaser Programs 13
Chases on Memory 18
CHECKSUM 37
CLEAR 34
CLEAR ALL 37
Color scrollers 35, 36
Colour changers 9

CONNECT 34
COPY 28
Copying the selected step 28
Coupling 38
Crossfade 17, 19
Crossfades between Memories 21
Cue Card 37
CURVE 35

D

Date and time 37
DBO 8
DELETE 28
Deleting the selected step 28
Dimmer channel 34
Dimmer Curve 35
Dimmerpacks 35
Dipless Crossfade (X-Fade) 19
DIRECT MEMORY 19, 20
Display 5
DISPLAY MEMORY 11
DMX 512 (1990) output 34, 41
Doubling the Channel Number 33

E

EDIT 14
Encoder wheel 5
ENTER 14, 28
ERROR 37
EXCHANGE MEMORY 37

F

FADETIME 17
FF=100% 26
Flash buttons 8
FLASH mode 36

G

GO button 24, 30
GO-Minus function 32
Grap mode 26

H

Hold 39

I

Incoming sound triggers the chase 16
INFADE 19
Infade time of the new picture 19
Input and Output 41
INSERT button 28

- K**
- Keyswitch 36
 - KILL mode 36
- L**
- LCD display 5
 - LEARN 18
 - LED's 8
 - Limit 26
 - LINEAR 35
 - LINK 23, 38
 - LIVE 25
 - LOAD FROM CARD 37
 - LOCK PROGRAMMING 36
 - LOCK DESK 36
- M**
- Main-Master 8
 - Mains (power supply) 41
 - MANUAL 19, 21
 - Manual Crossfades 21
 - Master-Slave Operation 38
 - MEM... button 31
 - Memories 10, 11
 - Memory Card 37
 - MEMORY Chase 13
 - Memory Chases 15
 - Memory Pages 10
 - Memory-Chaser 13, 15
 - MIDI Functions 39
 - MIDI IN / OUT / THRU 41
 - Modification on Memories 27
 - MODIFY 31
 - MODIFY MEMORY 27
 - Modifying a running X-Fade 30
 - Modifying Chase or Sequence Steps 28
 - Modifying MEMORY steps 31
 - Modifying ON/OFF steps 31
 - Modifying REAL LEVEL steps 31
 - Multi-funcional fixtures 36
- N**
- NEXT 21, 32
 - NO 15
 - "Number"-button 16
- O**
- "ON"-button 16
 - ON-OFF Chase 13, 14
 - OPEN 34
 - OUTFADE 19
 - Outfade time of the actual scene 19
 - OUTPUT 34, 41
 - Output Limit 26
 - Output values 25
- P**
- Page 10
 - PATCH 34
 - Pin layout 41
 - PREPARE MEMORY 19
 - Preprogrammed Lighting Shows 23
 - Preset Master fader 8
 - Presets 8
 - PREVIEW 29
 - Preview a Chase 29
 - Preview and Modifying a running X-Fade 30
 - PREVIEW button 25
 - Preview Chase 29
 - Preview Chase on Memory 29
 - Previewing a memory 27
 - Previewing and Modification on Memories 27
 - PRG CHASE/SEQUENCE 14
 - PROGRAM MEMORY 11
 - Programming sequences 23
- Q**
- Quick programming mode 11
 - QUIT button 5
- R**
- R/W - TEST 37
 - Real time clock 5
 - Real-Level 15
 - REAL-LEVEL Chase 13
 - Real-Level Chase 15
 - Real-Level-Chase 15
 - REC.FADE 19
 - Recalling a Chase 16
 - Recalling Sequences 24
 - Remote Control 38
 - REVERSE 17
 - RUNNING 29

S

SAVE OUTPUT 11
SAVE PRESET 2 11
SAVE TO CARD 37
Sequences 23
SINGLE 17
Single Channels 8
Socapex EF337 34, 41
Softpatch 34
SOUND 16
Sound input 41
Special Functions 33
SPEED 29
"Speed" button 17
Storage capacity 11
SWAP 16, 17
Switch Memories 12, 36
SWITCH OFF 19
Swop Buttons 8
Swop Disable 35
SWOP effect 36
SWOP function 8

T

Terminating the X-fade mode 19
Theatre Sequence 37
TIMED SEQUENCE 24
TOGGLE mode 36
Top Menu 5

U

UTILITY/SETUP 33

W

WIDE Function 33

X

X - Fade 19
X - FADE MEMORY 19, 20, 21
X - FADE SETUP 19
X - FADE CHASE 22
X - FADE OFF 32
X - FADE SETUP 19, 20
X - FADE TIMED SEQUENCE 24
X-Fade On/Of 19, 32
X-Fading a Chaser Program 22

Safety Instructions:

1. Read all the instructions in the user's manual.
2. Keep the user's manual for later use.
3. Follow all the instructions on the unit.
4. Pull the plug before cleaning the unit; don't use any liquid or spray cleaner. Clean with a damp cloth.
5. Don't use the unit near water.
6. Don't put the unit on unstable tables etc.. It might fall down and get damaged.
7. There are slots in the case for aeration; don't cover these slots up because they guarantee the reliable use of the unit and protect it against overheating. Don't install the unit into a frame unless sufficient aeration is guaranteed.
8. The unit is provided with a safety plug. This plug can only be used with safety sockets. These safety measures should by all means be followed. In case the plug doesn't fit into the socket (e.g. with old sockets), the socket should be replaced by an electrician.
9. Don't put any objects on the wire and make sure nobody steps on it.
10. In case you use an extension wire make sure the sum of the power consumption of the connected units does not exceed the maximum power of the wire. The sum of the units plugged in the socket should not exceed 10 Ampere.
11. Don't spill any liquid over the unit. Don't put any objects through the slots of the unit, as these might get in contact with parts that are live or might cause short circuits. This may cause fires and shocks.
12. Don't service the unit yourself as parts that are live might be exposed when you open the case; you run the risk of getting shocked. All services should only be carried out by a specialist.
13. If one of the following conditions occurs, please pull the plug out and call the service:
 - A. Wire or plug is damaged or worn.
 - B. Liquid got into the unit.
 - C. The unit was exposed to rain or got damp.
 - D. The unit doesn't work properly even if you follow the instructions of the user's manual.
 - E. The unit fell down and the case was damaged.
14. Only use wires which are marked safety proof.
15. Don't use any high-power walkie-talkies near the unit.

DECLARATION OF CONFORMITY

according to guide lines 89/336 EWG and 92/31 EWG:

Name of producer: MA Lighting Technology GmbH
Address of producer: Dachdeckerstr. 16
D-97297 Waldbüttelbrunn Germany

declares that the product

Name of product: MA Lightcommander 24/6 and 48/6
Type: LC 24/6 and LC 48/6

answers the following product specifications:

Safety: EN60065, resp. EN60965
EMV (EMC): EN55103-1 (E1), EN50081-1
EN55103-2 (E2), EN50082-1

Additional informations: All DMX512 and analogue inputs and outputs must be shielded and the shielding must be connected to the ground resp. to the case of the corresponding plug.

Waldbüttelbrunn, 07.11.1995



Dipl. Ing. Michael Adenau



Lightcommmander 24/6 - 48/6

User's Manual

Version 2.59

CE